



Parts Manual

Model 25D Carton Clamp

Serial Number 25D-CCS-157

cascade[®]

For Technical Assistance call: 800-227-2233, Fax: 888-329-8207

To Order Parts call: 888-227-2233, Fax: 888-329-0234

OR

Write: Cascade Corporation, P.O. Box 20187, Portland, OR 97220

Internet: www.cascorp.com

Safety Decals



REF	QTY	PART NO.	DESCRIPTION
1	1	679150	No Step Decal
2	2	665595	No Hand Hold Decal
3	1	679059	Quick Change Hook Decal

Publications



PART NO.	DESCRIPTION
670487	Service Manual
670834	Operators Guide
670488	Installation Instructions
680664	Servicing Cascade Cylinders-VHS
679929	Tool Catalog
673964	Literature Index Order Form

Base Unit Group

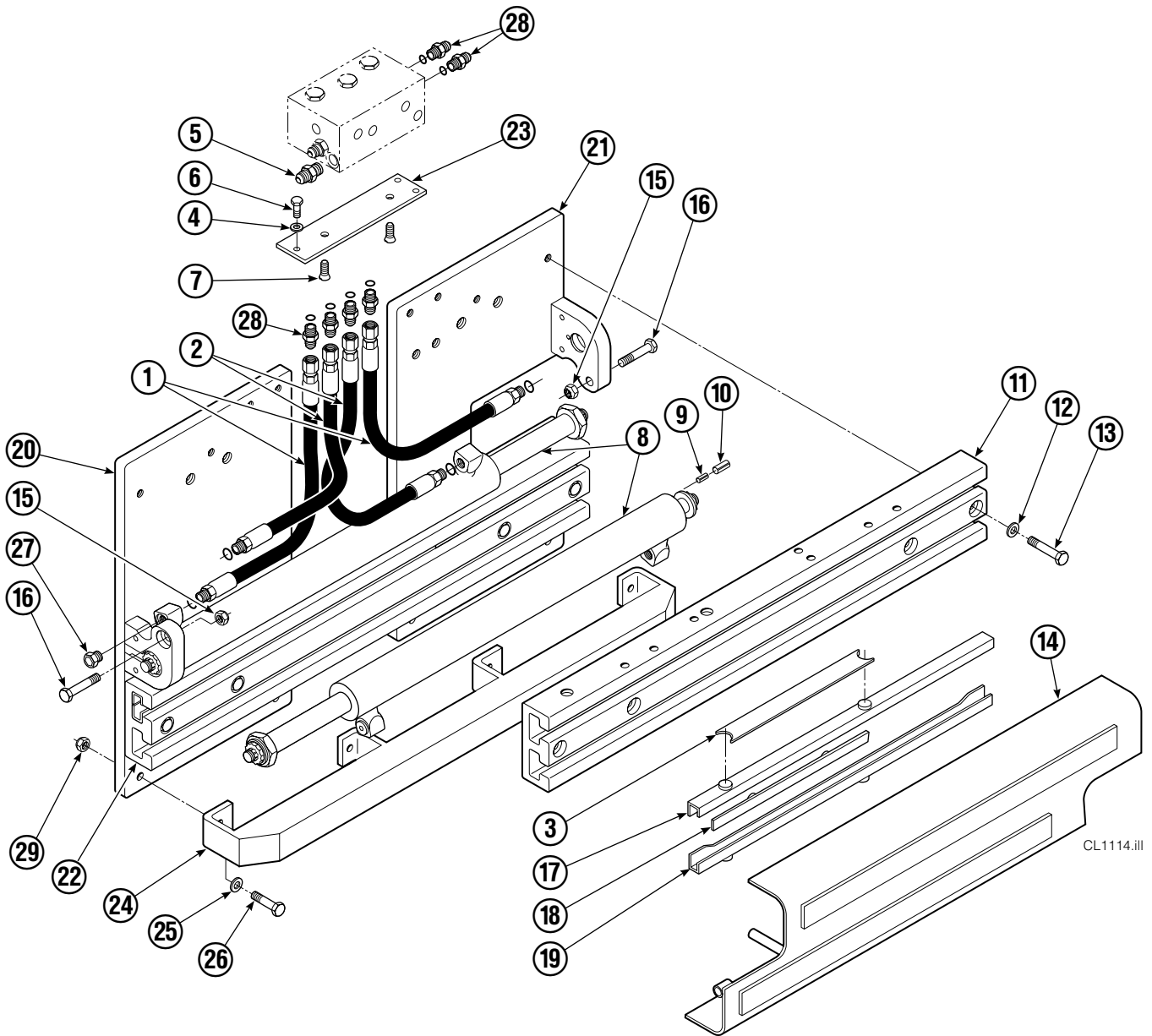

CL1114.iii

35D							
REF	QTY	PART NO.	DESCRIPTION	REF	QTY	PART NO.	DESCRIPTION
		6001077	Base Unit	15	2	773842	Nut, M12
1	2	387426	Hose	16	2	768414	Capscrew, M12x65
2	2	380141	Hose	17	4	208857	Bearing, Upper
3	1	675326	Shim Kit ■	18	4	667663	Bearing
4	2	209021	Washer, M10	19	4	208858	Bearing, Lower
5	1	601377	Fitting, 8-8	20	1	6001050	Mounting Plate - RH
6	2	684594	Capscrew, M10x20	21	1	6001043	Mounting Plate - LH
7	2	766646	Capscrew, M10x20	22	1	6001073	Frame - Lower
8	2	335968	Cylinder ▲	23	1	669957	Plate
9	2	768953	Roll Pin - Inner	24	1	671545	Bumper - Lower
10	2	769009	Roll Pin - Outer	25	4	202348	Washer, M12
11	1	6001071	Frame - Upper	26	4	768556	Capscrew, M12x45
12	8	667910	Washer	27	2	602580	Fitting, 8
13	8	684659	Capscrew, M12x75	28	6	611288	Fitting, 6-8
14	1	385203	Bumper	29	4	773842	Nut, M12

■ Includes two .015 Shims, and eight .020 Shims.

Reference: SK-6390, Common Parts: 210495.

▲ See Cylinder page or parts breakdown.

Cylinder

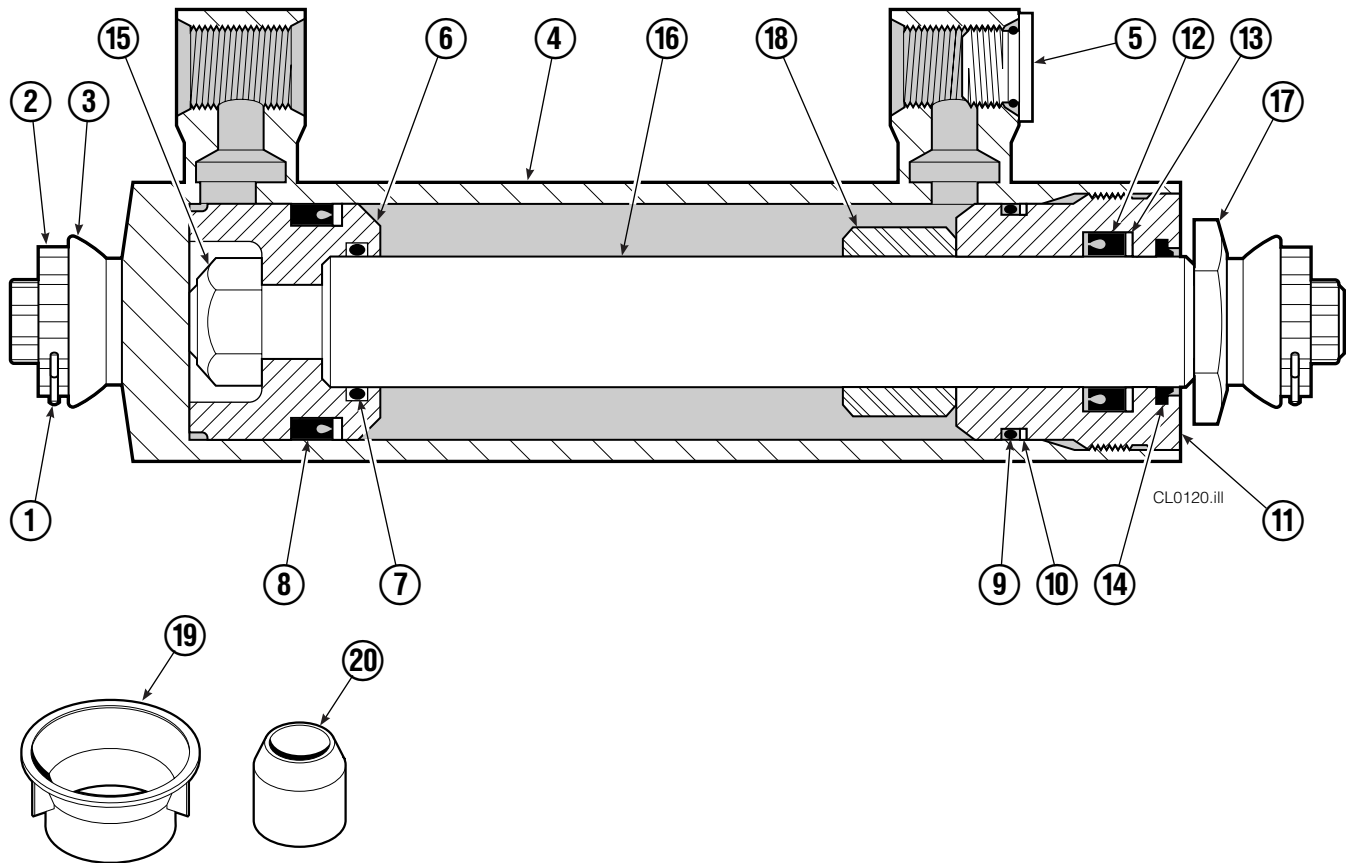

25D			
REF	QTY	PART NO.	DESCRIPTION
		335968	Cylinder Assembly
1	2	6510	Cotter Pin ■
2	2	667624	Nut Retainer ■
3	2	667625	Nut ■
4	1	335969	Shell
5	1	602580	Fitting
6	1	558200	Piston
7	1	2716	O-Ring ▲
8	1	662452	Seal ▲
9	1	2785	O-Ring ▲
10	1	615128	Back-Up Ring ▲
11	1	563906	Retainer
12	1	662448	Seal ▲
13	1	638243	Nylon Ring ▲
14	1	636853	Wiper ▲
15	1	667623	Nut
16	1	335970	Rod
17	1	667626	Washer
18	1	—	Spacer
19	1	671047	Seal Loader, Piston ▲
20	1	671051	Seal Loader, Retainer ▲
		668021	Service Kit

▲ Included in Service Kit 668021.

■ Included in Nut Service Kit 668926.

Reference: S-7605, S-7658

Check Valve



REF	QTY	PART NO.	DESCRIPTION	REF	QTY	PART NO.	DESCRIPTION
		669762	Check Valve – Flow Divider	11	2	667494	Fitting
1	1	667490	Special Fitting	12	2	2840	O-Ring ●
2	1	2841	O-Ring ●	13	2	673098	Spring
3	1	667471	Spool	14	2	667492	Poppet
4	2	609453	Fitting, 10	15	1	673089	Spool Assembly
5	2	667487	Spring	16	2	667491	Sleeve
6	6	604510	Fitting, 6	17	1	669763	Valve Body
7	1	678270	Check Valve – VPO	18	1	661347	Service Kit ●
8	2	659058	Check Valve – PO	19	1	676343	Regeneration Elimination Plug ■
9	2	667516	Service Kit ●			667513	Service Kit
10	1	679846	Low Flow Spool Kit				

● Included in Service Kit 667513.

■ For eliminating regeneration circuit only. See Tech. Bulletin 121.

Reference: SK-5302.

Arms and Pads

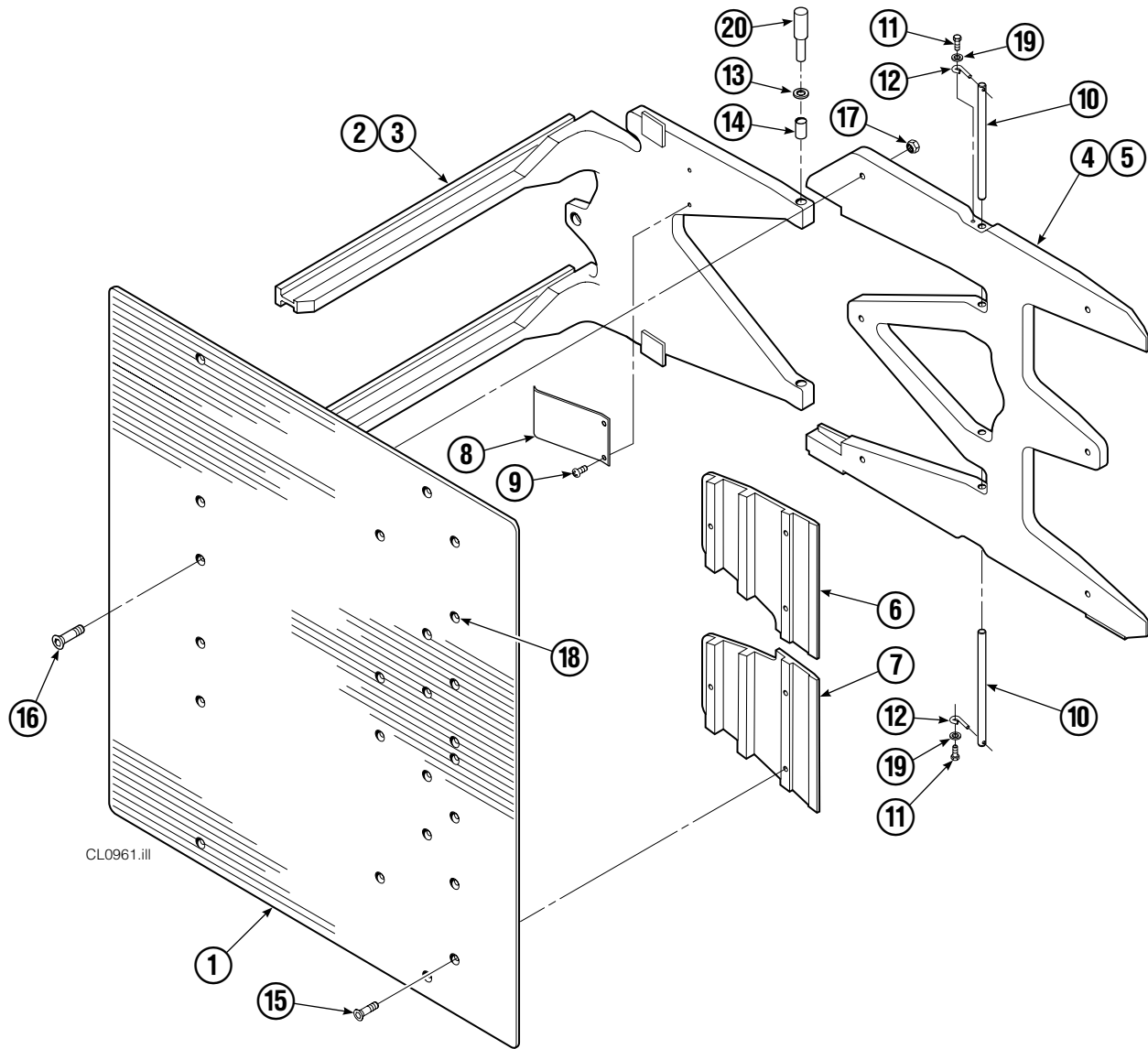

25D							
REF	QTY	PART NO.	DESCRIPTION	REF	QTY	PART NO.	DESCRIPTION
1	2	6001056	Contact Pad – 48 x 50 in.	11	4	787372	Capscrew, M8 x 20
2	1	6001058	Arm – LH	12	4	682999	Eye Pin
3	1	6001064	Arm – RH	13	10	675620	Washer, M10
4	1	393835	Stabilizer – LH	14	8	200590	Bushing
5	1	393852	Stabilizer – RH	15	12	766646	Capscrew, M10 x 20
6	2	210180	Filler Block – LH Upper/RH Lower	16	12	768706	Capscrew, M12 x 35
7	2	210179	Filler Block – RH Lower/RH Upper	17	12	773842	Nut, M12
8	2	210154	Spring	18	▲	676841	Contact Pad Repair Kit
9	4	203405	Capscrew, M10 x 16	19	4	787398	Washer, M8
10	4	210161	Pin	20	1	675626	Tool – Bushing Driver

Reference: Stabilizer Group 393818, Common Parts 210495, S-10436, S-10437.

▲ Repairs one hole.

Quick-Change Mounting Group



REF	QTY	ITA II	DESCRIPTION
		PART NO.	
		211162	Upper Mounting Group ▲
		211174	Lower Mounting Group ●
1	2	210491	Upper Hook
2	4	768577	Capscrew, M20 x 35
3	1	212999	Center Key
4	2	211129	Capscrew, M16 x 35
5	2	675514	Lower Hook
6	2	675515	Guide
7	2	678832	Pin
8	4	211180	Capscrew, M16 x 30

▲ Includes items 1–4.

● Includes items 5–8.

Reference: SK-6390.

Backrest Group

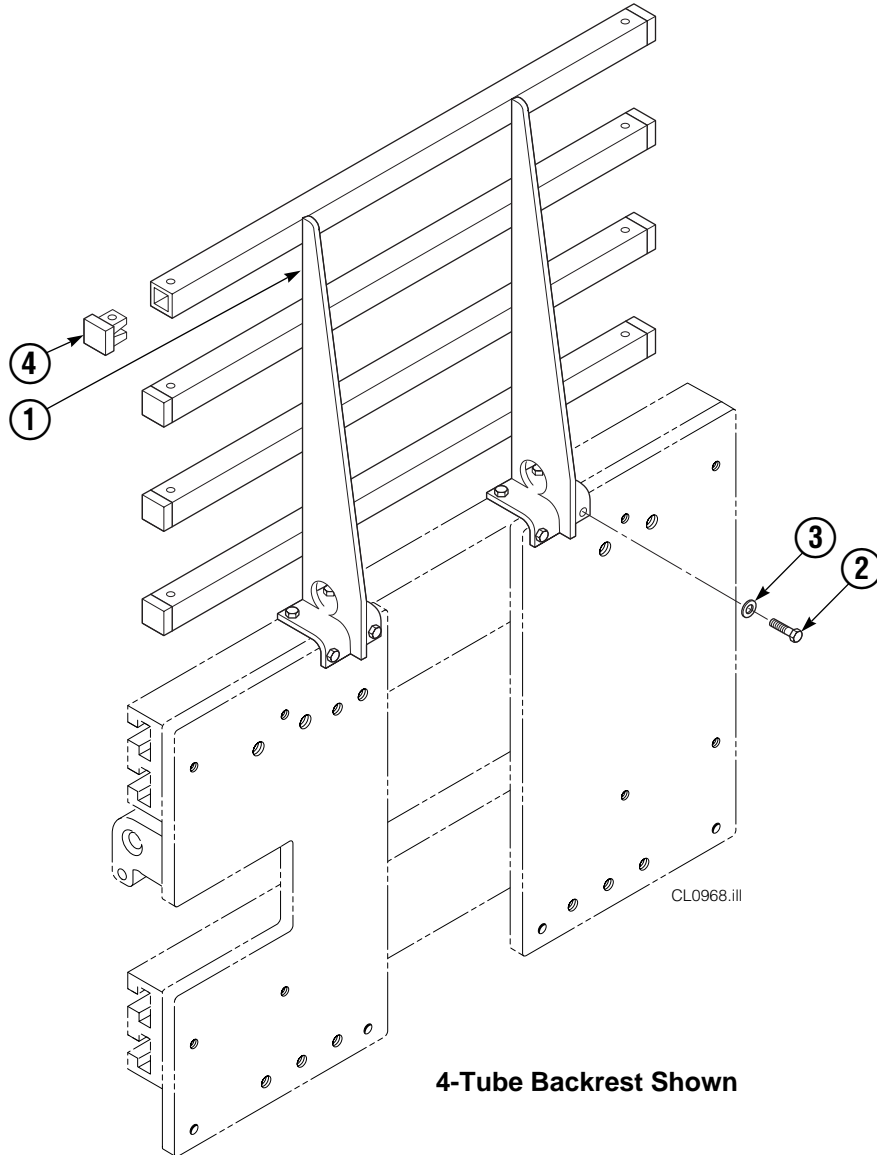

15D			
REF	QTY	PART NO.	DESCRIPTION
		221577	Backrest Group
1	1	669897	Backrest
2	8	768810	Capscrew, M10x30
3	8	667910	Washer, M10
4	8	674356	Tube End

Reference: SK-6390.

Do you have questions you need answered right now? Call your nearest Cascade Parts Department.

Cascade Corporation
2501 Sheridan Avenue
Springfield, OH 45505
Tel: 888-CASCADE (227-2233)
FAX: 888-329-0234
www.cascorp.com

Cascade Canada Inc.
5570 Timberlea Blvd.
Mississauga, Ontario
Canada L4W-4M6
Tel: 905-629-7777
FAX: 905-629-7785

Cascade GmbH
D-41199 Monchengladbach
Klosterhofweg 52
Germany
Tel: 21-66-602091
FAX: 21-66-680947

Cascade Finland
01370 Vantas
Finland
Tel: 358-0-836-1925
FAX: 358-0-836-1935

**Cascade N.V.
European Headquarters**
P.O. Box 3009
1300 El Almere
Damsluisweg 56
1332 ED Almere
The Netherlands
Tel: 31-36-5492911
FAX: 31-36-5492964

**Cascade N.V.
Benelux Sales and Service**
P.O. Box 3009
1300 El Almere
Damsluisweg 56
1332 ED Almere
The Netherlands
Tel: 31-36-5492950
FAX: 31-36-5492974

Cascade (UK) Ltd.
15, Orgreave Crescent
Dore House Industrial Estate
Handsworth
Sheffield S13 9NQ
England
Tel: 742-697524
FAX: 742-695121

**Cascade Scandinavia
Hydraulik A.B.**
Muskötgatan 19, E8-9
S25466 Helsingborg
Sweden
Tel: 42-151135
FAX: 42-152997

Cascade Norway
Østerliveien 37A
1153 Oslo
Norway
Tel: 47-22-743160
FAX: 47-22-743157

Cascade France S.A.R.L.
11, Rue Jean Charcot
Zone Industrielle Sud or
B.P. 22
91421 Morangis Cedex
France
Tel: 1- 64547501
FAX: 1-9790584

Cascade Hispania S.A.
Avenida De La Fabregada, 7
Hospitalet De Llobregat
Barcelona
Spain
Tel: 3-335-5158
FAX: 3-335-4756

Cascade Japan Ltd.
5-5-41,
Torikai Kami
Settsu, Osaka
Japan, 566
Tel: 81-726-53-3490
FAX: 81-726-53-3497

Cascade Korea
Room 508, Pum Yang Bldg.
750-14, Bang Bac-Dong
Se-Cho Ku, Seoul
Korea
Tel: 2599-7131 ext. 512
FAX: 2533-8089

HYCO-Cascade Pty. Ltd.
1445 Ipswich Road
Rocklea,
Queensland 4107
Australia
Tel: 3-274-2722
FAX: 3-274-3456

HYCO-Cascade (NZ) Ltd.
15 Ra Ora Drive, East Tamaki
P.O. Box 38-440
Howick, Auckland
New Zealand
Tel: 9-273-9136
FAX: 9-273-9137

Cascade (Africa) Pty. Ltd.
P.O. Box 625, Isando 1600
60A Steel Road
Sparton, Kempton Park
South Africa
Tel: 975-9240
FAX: 394-1147

Cascade-Xiamen
Wanshan No. 1 Workshop
Huli Road
Xiamen 361006
Fujian, PRC
Tel: 592-562-4600
FAX: 592-562-4671

**Cascade (Singapore)
Trading Co.**
Four Seasons Park
Autumn Block - Apt. 1802
12 Cascaden Walk
Singapore
Tel: 65-834-1935
FAX: 65-834-1936

