



Parts Manual

Model Sideshifter

Serial Number 100E-SSS-B204

cascade[®]
corporation

For Technical Assistance call: 800-227-2233, Fax: 888-329-8207

To Order Parts call: 888-227-2233, Fax: 888-329-0234

OR

Write: Cascade Corporation, P.O. Box 20187, Portland, OR 97220

Internet: www.cascorp.com

Publications

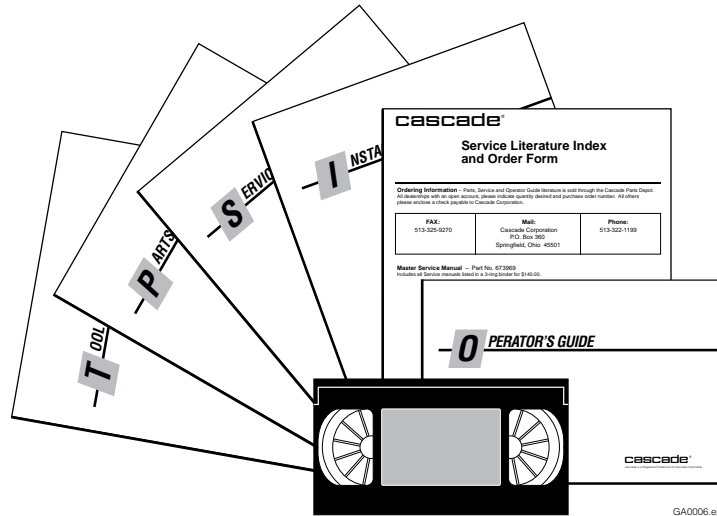

GA0006 eps

100E Sideshifter	
PART NO.	DESCRIPTION
	Parts Manual
205849	Service Manual
205124	Operator Guide
205125	Installation Instruction
679929	Tool Catalog
673964	Literature Index Order Form

Sideshifter Assembly

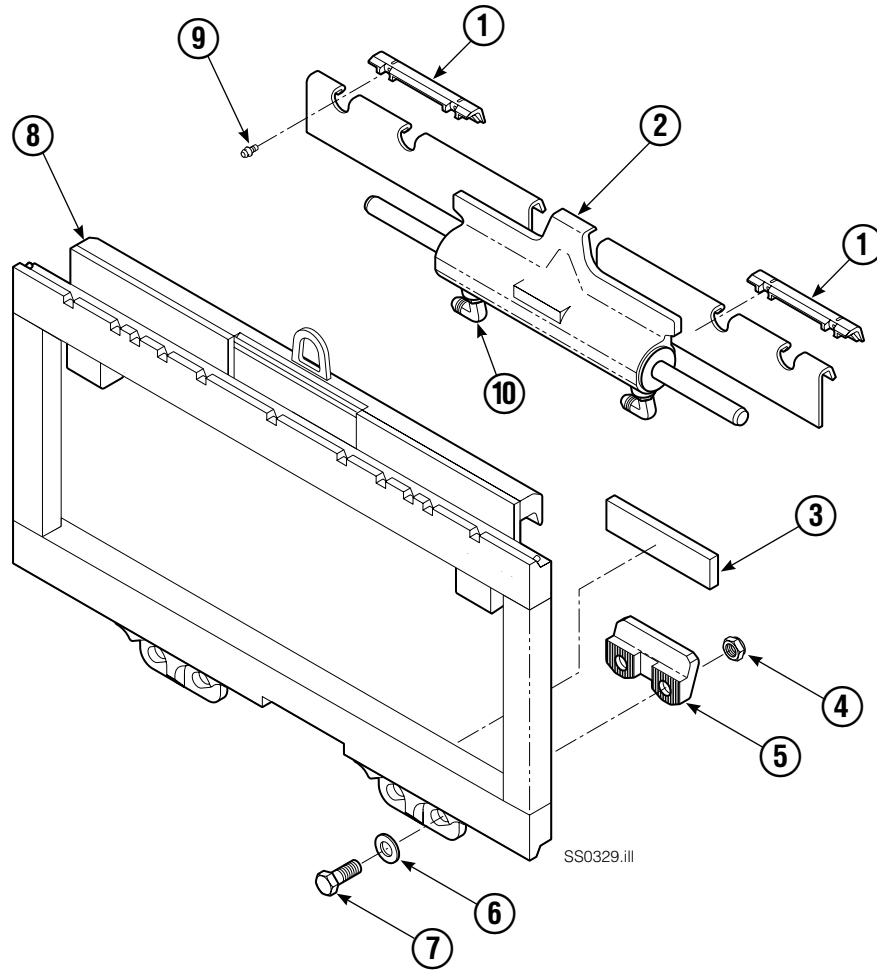

100E			
REF	QTY	PART NO.	DESCRIPTION
1	2	672018	Upper Bearing
2	2	584003	Cylinder Assembly ●
3	2	208350	Lower Bearing
4	4	553857	Nut ▲
5	2	204186	Lower Hook ▲
6	4	667225	Washer ▲
7	4	639121	Capscrew, 5/8 NCx1.50 GR5 ▲
8	1	6028119	Frame ★
9	2	7403	Grease Fitting
10	2	601676	Fitting, 6-6 ■

● See Cylinder page for parts breakdown.

▲ Included in Lower Hook Group 204182.

■ Included in Fitting Group 204179.

★ If frame needs replacing, order complete Sideshift Assembly.

Reference: Common Parts Group 208368. S-4061, 4010 Frame Groups.

Cylinder

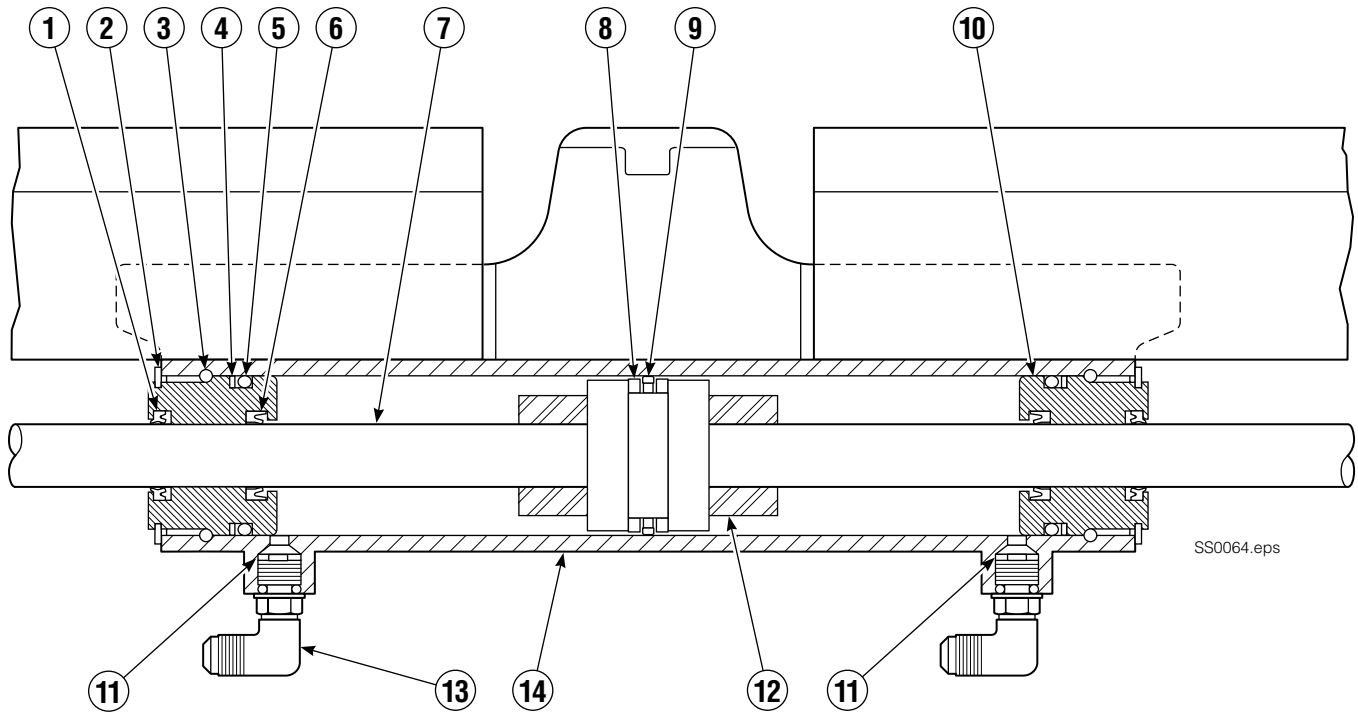

SS0064.eps

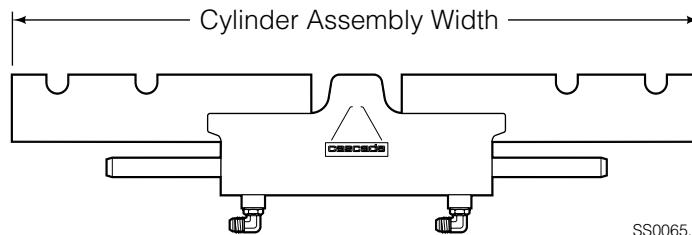

SS0065.ill

100E

REF	QTY	PART NO.	DESCRIPTION	REF	QTY	PART NO.	DESCRIPTION
		584003	Cylinder Assembly, 48.1 in. (1220 mm)	● 8	2	564404	Bearing Ring
● 1	2	564408	Wiper Seal	● 9	1	564407	Piston Seal
2	2	7210	Snap Ring	10	2	564402	Retainer
3	2	564403	Retaining Ring	11	2	205369	Speed Control Washer
● 4	2	615131	Back-Up Ring	12	2	-	Spacer
● 5	2	2789	O-Ring	13	2	604511	Fitting, JIC 6-6
● 6	2	564406	Rod Seal	14	-	■	Cylinder Shell
7	1	564401	Rod			564409	Service Kit

● Included in Service Kit 564409.

■ Not serviceable, order new cylinder assembly.

Reference: Restrictor Group, 205369.

Do you have questions you need answered right now? Call your nearest Cascade Parts Department.

Cascade Corporation

2501 Sheridan Avenue
Springfield, OH 45505
Tel: 888-CASCADE (227-2233)
FAX: 888-329-0234
www.cascorp.com

Cascade Canada Inc.

5570 Timberlea Blvd.
Mississauga, Ontario
Canada L4W-4M6
Tel: 905-629-7777
FAX: 905-629-7785

Cascade GmbH

D-41199 Monchengladbach
Klosterhofweg 52
Germany
Tel: 49-216-668230
FAX: 49-216-6682323

Cascade Finland

Albert Petreliuksenkatu 3
01370 Vantaa
Finland
Tel: 358-9-836-1925
FAX: 358-9-836-1935

**Cascade N.V.
European Headquarters**

P.O. Box 3009
1300 El Almere
Damluisweg 56
1332 ED Almere
The Netherlands
Tel: 31-36-5492911
FAX: 31-36-5492964

**Cascade N.V.
Benelux Sales and Service**

P.O. Box 3009
1300 El Almere
Damluisweg 56
1332 ED Almere
The Netherlands
Tel: 31-36-5492950
FAX: 31-36-5492974

Cascade (UK) Ltd.

15, Orgreave Crescent
Dore House Industrial Estate
Handsworth
Sheffield S13 9NQ
England
Tel: 742-697524
FAX: 742-695121

Cascade Scandinavia AB

Box 124
Hammarvägen 10
567 23 Vaggeryd
Sweden
Tel: 42-0-393-36950
FAX: 46-0-393-36959

Cascade Norway

Østerliveien 37A
1153 Oslo
Norway
Tel: 47-22-743160
FAX: 47-22-743157

Cascade France S.A.R.L.

1D Rue De Charaintru
BP 18, 91360 Epinay-Sur-Orge
Morangis Cedex, France
Tel: 33-1- 64547500
FAX: 33-1-64547501

Cascade Hispania S.A.

Carrer 5 Sector C
Zona Franca Duanera
Poligono de la Zon Franca
08040 Barcelona, Spain
Office No. 256
Tel: 93-264-07-30
FAX: 93-264-07-31

Cascade Japan Ltd.

5-5-41,
Torikai Kami
Settsu, Osaka
Japan, 566
Tel: 81-726-53-3490
FAX: 81-726-53-3497

Cascade Korea

108B, Namdong Ind Complex
658-3 Gojan-Dong
Namdong-Gu
Inchon, 405-310 Korea
Tel: 82-32-821-2051
FAX: 82-32-821-2055

Cascade Australia

1445 Ipswich Road
Rocklea, QLD 4106
Australia
Tel: 1-800227-223
FAX: (07) 3373-7333

Cascade New Zealand

15 Ra Ora Drive
East Tamaki, Auckland
New Zealand
Tel: 9-273-9136
FAX: 9-273-9137

Cascade (Africa) Pty. Ltd.

P.O. Box 625, Isando 1600
60A Steel Road
Sparton, Kempton Park
South Africa
Tel: 27-11-975-9240
FAX: 27-11-394-1147

Cascade-Xiamen

No. 668 Yangguang Rd.
Xinyang Industrial Zone
Haicang, Xiamen City
Fujian Province
P.R. China 361026
Tel: 86-592-651-2500
FAX: 86-592-651-2571

**Cascade (Singapore)
Trading Co.**

Four Seasons Park
Autumn Block - Apt. 1802
12 Cuscaden Walk
Singapore
Tel: 65-834-1935
FAX: 65-834-1936

